



Trunnion mounted ball valves RF ANSI class #300



VIT-30009

Max temperature: 120°C

Design & construction: API 608, API 6D

Face to face length: ASME / ANSI B16.10

Connections & dimensions: ASME / ANSI B16.5

Flanges: RF ANSI #300

Pressure & temperature: ASME / ANSI B 16.34

Test: API 598

Fire safe test: API 607 / API spec. 6FA & BS 6755 part 2

The trunnion mounted ball valves are used for oil and petrochemicals on big pipelines sizes and in case of severe conditions. Trunnion mounted ball valves are manufactured according to ANSI-API standard. The valve is operated by gear box.

Materials

body - bonnet	cast steel A216WCB, GP240GH+N
ball	A 182 F304 / A216 WCB
seat ring	PTFE
stem	steel A105 / A182 F6
spring	inconel / alloy
painting	high chlorinated polyethylene HCPE

Dimensions

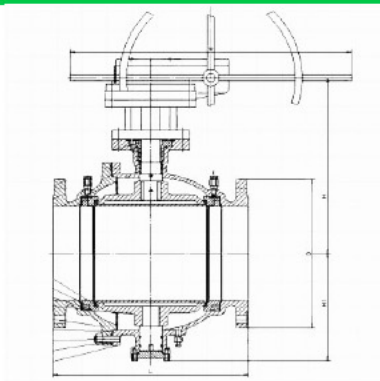

DN	L mm.	H1 mm.	H mm.	D mm.	Ø W mm.
2"	216	110	147	165	230
2"1/2	241	130	175	190	400
3"	283	140	216	210	400
4"	305	160	250	254	700
5"	381	180	335	279	600
6"	403	210	378	318	600
8"	502	255	421	381	600
10"	568	310	482	445	600
12"	648	350	550	521	800
14"	762	390	582	584	800
16"	838	440	687	648	800
18"	914	480	730	711	800
20"	991	540	772	775	800
24"	1143	640	948	914	800

Pressure

Hydrostatic test

Pneumatic test

shell

seat

bars

psig

bars

psig

bars

psig

78

1130

58

840

≥ 5,6

≥ 80